

Article number: 2301072821

Description: E+G Handwheel  
VDS.175+IRS-A16

## Measures

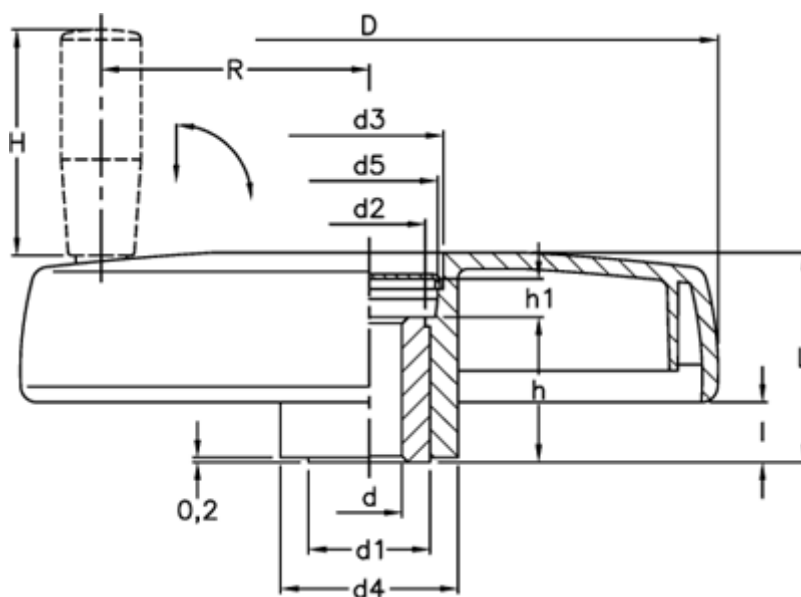

C (N m) = 195	H = 80
D = 176	h = 28
d1 = 35	h1 = 16
d2 = 33.0	l = 13
d3 = 39.0	L = 49
d4 = 44	L (J) = 20
d5 = 35	R = 70
d H7 = 16	